



“myReference,,

CREATION 55

LOOSELAY

**Gerflor**<sup>®</sup>  
theflooringgroup



# CREATION 55

## LOOSELAY

500 x 500 mm 229 x 1220 mm

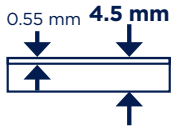

### PUR+ MATT



Easy maintenance

### 4D DESIGN

#### STRUCTURED EMOSS



Ultra realistic surface

#### MATT SURFACE



Natural look

#### CRISTAL WEAR LAYER



High definition design & color

#### MIX&MATCH DESIGNS



Easy mix&match of designs & formats\*

### DUO CORE TECHNOLOGY

#### 1 RESILIENT COMFORT CORE



Noise absorption



Soft underfoot

#### 2 RIGID CORE

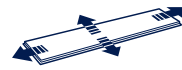

The best stability  
Fiber glass inside



Renovation ceramic  
4 mm joint



No adhesive up  
to 30 m<sup>2</sup>\*

### GRIP-WAVE BACKLAYER

#### ANTI-SKID BACKING



Super strong suction  
to the subfloor

Air circulation:  
better acoustic

Humidity circulation:  
moisture resistance



Easily removable:  
renovation

CREATION 55 LOOSELAY  
WOOD UNIVERSE



SWISS OAK PEARL - 0846  
229 mm x 1220 mm



4

DESIGN SHADE VARIATION:



Light



Medium



High



SWISS OAK PEARL



SWISS OAK GOLDEN - 0796  
229 mm x 1220 mm



CREATION 55 LOOSELAY  
WOOD UNIVERSE



ARENA - 0060  
229 mm x 1220 mm



MALUA BAY - 0448  
229 mm x 1220 mm



ARENA



MALUA BAY

6

DESIGN SHADE VARIATION:



Light



Medium



High



TWIST - 0504  
229 mm x 1220 mm



LONG BOARD - 0455  
229 mm x 1220 mm



TWIST

CREATION 55 LOOSELAY  
WOOD UNIVERSE



AMADOR - 0447  
229 mm x 1220 mm



RANCH - 0456  
229 mm x 1220 mm



8

DESIGN SHADE VARIATION:



Light



Medium



High



AMADOR



RANCH





HONEY OAK



BALLERINA



HONEY OAK - 0441  
229 mm x 1220 mm



BALLERINA - 0347  
229 mm x 1220 mm



CREATION 55 LOOSELAY  
MINERAL UNIVERSE

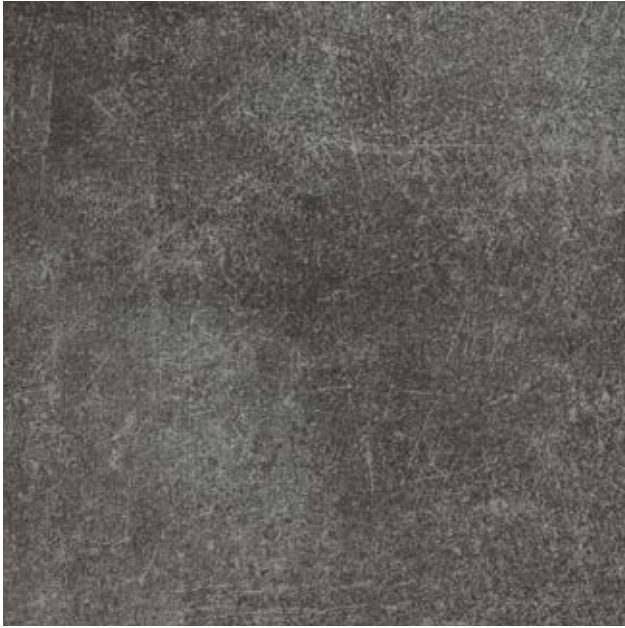

PARKER STATION - 0374  
500 mm x 500 mm



PARKER STATION



NORVEGIAN STONE - 0860  
500 mm x 500 mm



NORVEGIAN STONE





CARMEL



CARMEL



CARMEL - 0618  
500 mm x 500 mm



CREATION 55 LOOSELAY  
TEXTILE UNIVERSE



PONTO CRUZ CITY - 0878  
500 mm x 500 mm



12

DESIGN SHADE VARIATION:



Light



Medium



High



PONTO CRUZ CITY

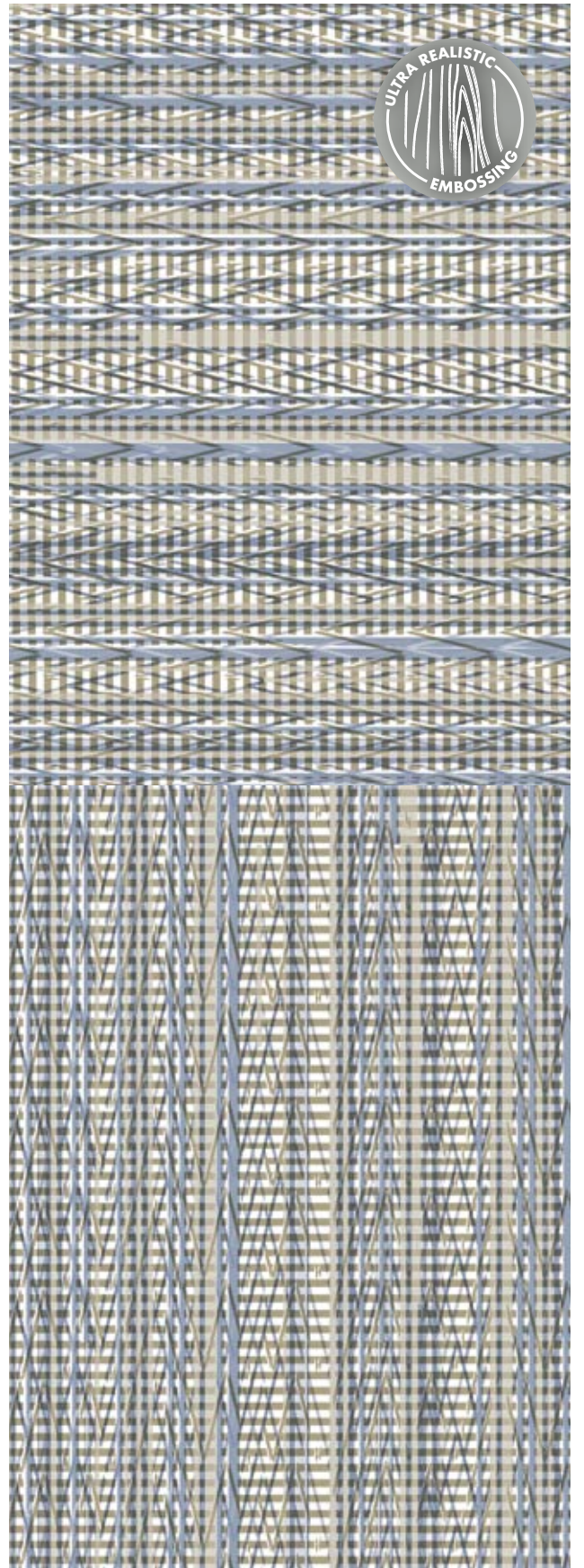

PONTO CRUZ NAVY - 0876  
500 mm x 500 mm



# EXPLORE THE WORLD OF POSSIBILITIES

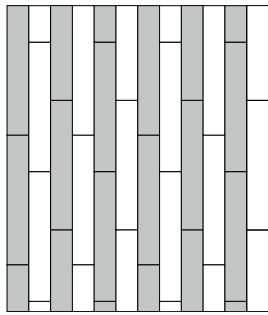

SLIM STRIPES

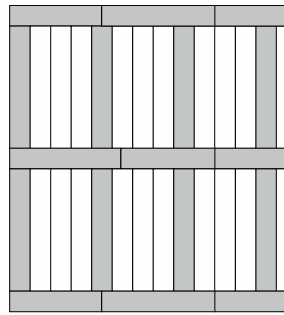

FENCE

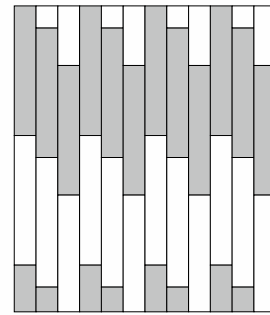

ACCORDEON

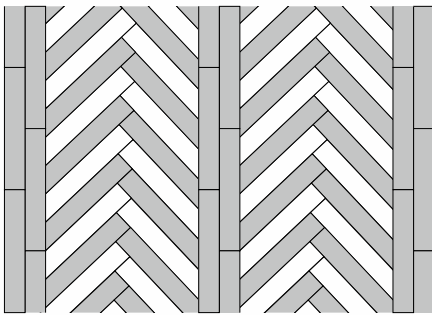

RYTHME

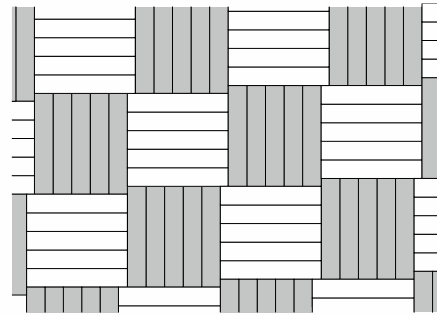

TRICOT

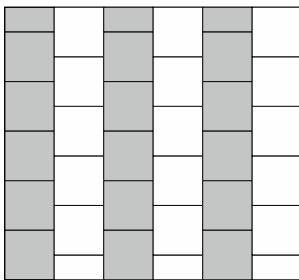

FAT STRIPES

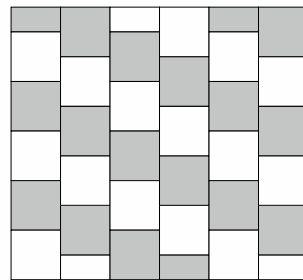

PIANO

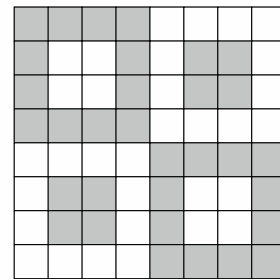

TARGET

## SLIM STRIPES



## QUICK & EASY TO INSTALL



INSTALLATION WITH TACKIFIER



APPLY PLANKS OR TILES



PRESSURE ROLLER



EASY TO REPAIR

## INSTALLATION



OVER RAISED  
ACCESS FLOOR

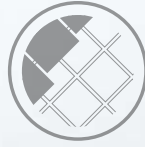

OVER CERAMIC  
TILES



ADHESIVE FREE  
UNDER 30M<sup>2</sup>

*Please refer to Gerflor's installation guidelines*





ACCORDEON







RYTHME





TARGET .....

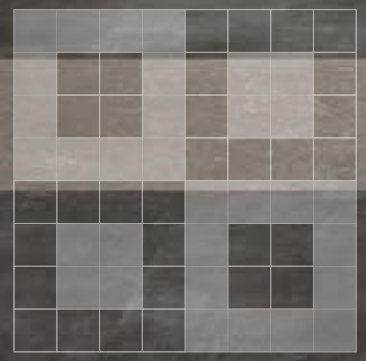

CAPPUCCINÔ





PIANO





FAT STRIPES





TRICOT





# CREATION 55 LOOSELAY A FULL SET OF FINISHES

## DESIGN SKIRTINGS

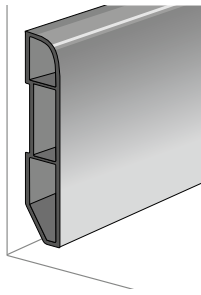
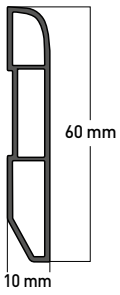

Vinyl design skirting  
Ref. 6086

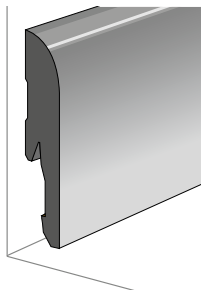
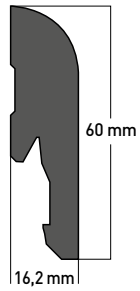

MDF design skirting  
Ref. 5947



ALL COLOURS AVAILABLE

## OTHER SKIRTINGS

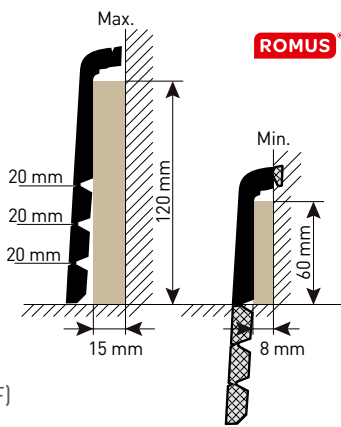

Cover skirting (MDF)  
Ref. 2550

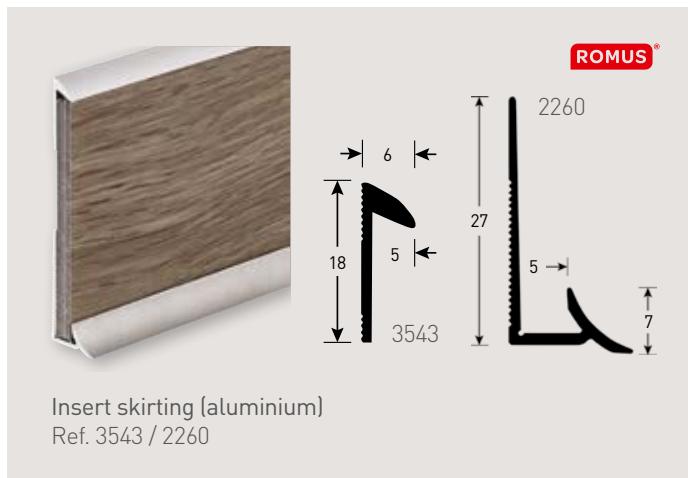

Insert skirting (aluminium)  
Ref. 3543 / 2260

## STAIRNOSING SOLUTION

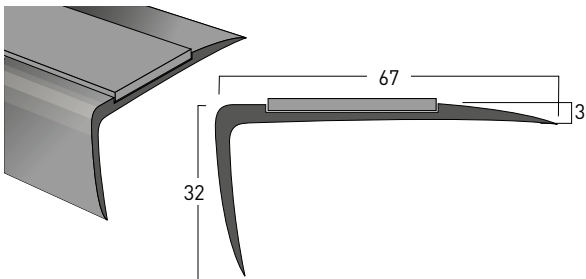

Nosing T67 (aluminium)  
Ref. 0503

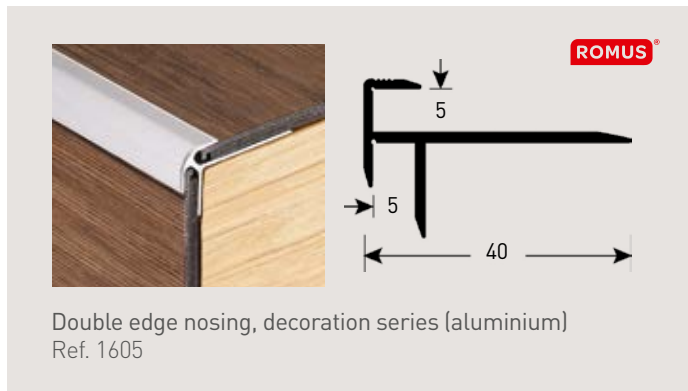

Double edge nosing, decoration series (aluminium)  
Ref. 1605



## PROFILES

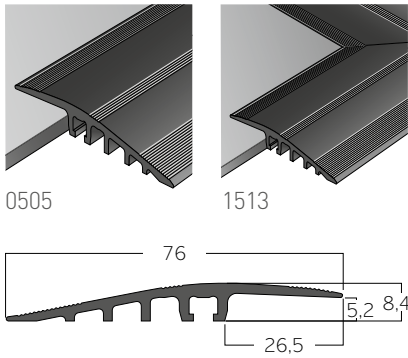

Ramp 5-6mm (aluminium)  
Ref. 0505



## ENTRANCE MATS



Looselay Romat GT insert kit  
Ref. 1719

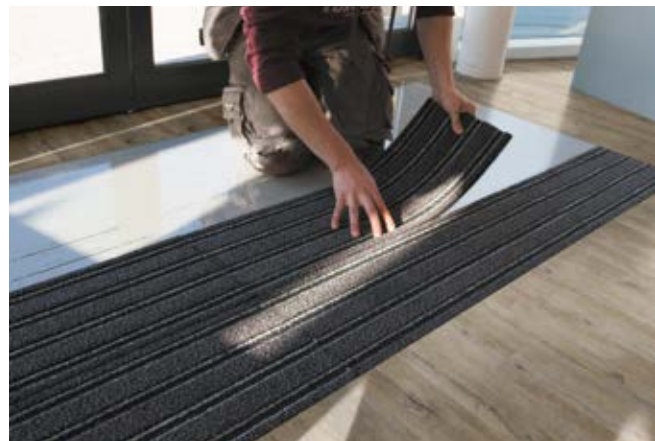

Quick mat  
Ref. 8550

**ROMUS**

## FLOOR PROTECTION



Floor protection  
Ref. 058X

FOR MORE DETAILS  
visit [gerflor.com](http://gerflor.com)



LVT finishes brochure



# CREATION 55 LOOSELAY

## TECHNICAL DATA

### CREATION 55 LOOSELAY

#### DESCRIPTION / BESCHREIBUNG / BESCHRIJVING / DESCRIPTION / DESCRIPCIÓN / DESCRICÃO / DESCRIZIONE

Total Thickness / Gesamtdicke / Totale dikte / Épaisseur totale / Espesor total / Espessura total / Spessore totale	EN ISO 24346 [EN 428]	mm	4.50
	ASTM F386-02	inch	0.18
Thickness of the wearlayer / Dicke der Nutzschrift / Dikte van de slijtlaag / Épaisseur couche d'usure / Espesor capa de uso / Espessura camada de desgaste / Spessore strato di usura	EN ISO 24340 [EN 429]	mm	0.55
	ASTM F410-02	inch	0.02
Weight / Flächengewicht / Gewicht / Poids / Peso / Peso / Peso	EN ISO 23997 [EN 430]	g/m <sup>2</sup>	7500
Size / Format / Afmetingen / Format / Dimensiones / Dimensões / Dimensione	ISO 24342 [EN 427]	mm	229x1220 500x500
	ASTM F 536	inch	9" x48" 19.7" x19.7"

#### CLASSIFICATION / KLASSIFIKATION / CLASSIFICATIE / CLASSIFICATION / CLASIFICACIONES / CLASSIFICAÇÕES / CLASSIFICAZIONI

Norm/Product Specification / Produktnorm / Technische eigenschappen / Norme/ Spécification produit / Normas / Normas / Norma prodotto	-	-	EN ISO 10582 [EN 649]
European Classification / Europäische Klassifizierung / Europese classificatie / Classement européen / Classificación europea / Classificação Europeia / Europea	EN ISO 10874 [EN 685]	Class	33 - 42
Fire Rating / Brandverhalten / Brand classificatie / Classement Feu / Fuego / Fogo / Reazione al fuoco	EN 13 501-1	Class	Bfl-s1
Static Electrical Propensity / Begehaufladung / Elektrische eigenschappen / Potentiel de charge / Comportamiento electrostático / Comportamento electrostático / Resistenza elettrica	EN 1815	kV	< 2
Slip Resistance Wet / Rutschhemmung / Anti-slip / Glissance humide / Deslizamiento húmedo / Escorregamento húmido / Scivolosità umida <sup>(1)</sup>	DIN 51130 / BGR 181	Class	R10

#### PERFORMANCES / TECHNISCHE EIGENSCHAFTEN / TESTRESULTAAT / PERFORMANCE / CUALIDADES TÉCNICAS / PERFORMANCES / CARATTERISTICHE TECNICHE

Wear Resistance / Verschleißverhalten / Slijtvastheid / Résistance à l'usure / Abrasión / Abrasão / Resistenza all'abrasione	EN 660.2	mm <sup>3</sup>	≤ 2.0
Wear Group / Verschleißgruppe / Groep slijtvastheid / Groupe d'abrasion / Grupo de abrasión / Grupo de abrasão / Gruppo di abrasione	EN 652	group	T
Type Binder content / Bindemittelgehalt / Teneur en agent liant / Contenido en ligante / Conteúdo em ligante	ISO 10582	group	I
Dimensional Stability / Maßstabilität / Maatvastheid / Stabilité dimensionnelle / Estabilidad dimensional / Estabilidade dimensional / Stabilità dimensionale	EN ISO 23999 [EN 434]	%	≤ 0.10
Residual Indentation / Resteindruck / Indrukbelasting / Poinçonnement statique rémanent / Punzonamiento / Punçoamento / Impronta	EN ISO 24343-1 [EN 433]	mm	≤ 0.10
Impact sound insulation / Trittschallverbesserungsmaß / Geluidsisolatie / Isolation acoustique bruits de chocs / Acústica / Isolamento acústico	EN ISO 717-2	dB	7
Room Impact / Raumschall / Loopgeluid / Sonorité à la marche / Rumore al calpestio / Sonoridad en la pisada / Sonoridade ao andar	NF S 31074	dB	73
Castor chair test / Stuhlrollenbeanspruchung / Rolweerstand bureaustoelen / Essai de la chaise à roulettes / Determinación del efecto de una silla con ruedas / Resistência a cadeiras de rodas / Resistenza al passaggio di sed (Type W)	ISO 4918 [EN 425]	-	OK
Thermal Conductivity / Wärmeleitfähigkeit / Thermische weerstand / Conductivité thermique / Conductividad térmica / Contutividade térmica / Resistenza termica / Värmeledningsmotstånd / Varmemotstånd	EN ISO 10456 [EN12524]	W/(m.K)	0.25
Colour Fastness / Lichtechtheit / Lichtecheit / Solidité lumière / Resistencia a la luz / Estabilidade das cores / Solidità alla luce	EN 20 105 - B02	degree	> 6
Surface Treatment / Oberflächenvergrüung / Oppervlaktebehandling / Traitement de surface / Tratamiento de superficie / Tratamento de superficie / Trattamento di superficie	-	-	PUR+ Matt
Chemical Products Resistance / Verhalten gegenüber Chemikalien / Chemische beständigheid / Résistance aux produits chimiques / Resistencia a los productos químicos / Resistência aos produtos químicos / Resistenza ai prodotti chimici <sup>(2)</sup>	EN ISO 26987 [EN 423]	-	OK

#### ENVIRONMENT/INDOOR AIR QUALITY / UMWELT/RAUMLUFTQUALITÄT / ENVIRONNEMENT/QUALITE DE L'AIR INTERIEUR / MEDIO AMBIENTE/CALIDAD INTERIOR DEL AIRE INTERIOR / MEIO AMBIENTE/QUALIDADE DO AR INTERIOR

TVOC after 28 days / TVOC (28 Tage) / TVOC (28 dagen) / TVOC après 28 jours / TVOC (28 dias) / TVOC (28 dias) / TVOC (28 giorni) / TVOC (28 dagar) / TVOC (28 dager)	ISO 16000-6	µg/m <sup>3</sup>	< 10
---	-------------	-------------------	------

#### CE MARKING / CE KENNZEICHNUNG / EG\_CONFORMITEITSMERK / MARQUAGE CE / MARCA DE CONFORMIDAD CE / MARCA DE CONFORMIDADE CE / MARCATURA CE DI CONFORMITA

	EN 14041	-	   
---	----------	---	---

(1) Ramp test with oil / Schiefe Ebene / Plan incliné avec huile

(2) Beständig gegenüber nicht färbenden alkoholhaltigen Handdesinfektionsmitteln, Haushaltschemikalien und verdünnten Säuren und Laugen bei kurzzeitiger Einwirkung.

## CREATION, NO FORMALDEHYDE, BETTER INDOOR AIR QUALITY



**COMPOSITION**  
100% REACH  
Phthalate Free  
(except recycled content)



**INDOOR  
AIR QUALITY**  
TVOC below detection level  
No Formaldehyde emission



**RECYCLABILITY**  
100%



**RECYCLED  
CONTENT**  
35%



**WELLNESS**  
Walking noise: 73dB

**Gerflor International**  
Tel: +33 (0)4 74 05 40 00  
Fax: +33 (0)4 74 05 03 13  
e-mail: gerflorcontract@gerflor.com

**ROMUS**  
ZA Les Pouards  
13 et 15, Rue Taillefer  
91160 Champlan  
France  
Tel : +33 (0) 1 69 79 69 77  
email: welcome@romusworld.com  
www.romusworld.com

**Visualize your reference**



[interiordesigner.gerflor.com](http://interiordesigner.gerflor.com)

**30 years experience**  
Since 1985

**Manufacturer**  
3 LVT Factories

**World Class Logistics**  
12 Logistics Hubs

**Gerflor Design Centre**  
Exclusive Designs



**“Serenity,,**  
Julia - **End User**



**“Time saving,,**  
Mika - **Installer**



**“Design,,**  
Pierre - **Architect**



**“Confidence,,**  
Claire - **Store Manager**



**“Flexibility,,**  
Hans - **Distributor**

That's why Creation is our **Reference**

**Gerflor**<sup>®</sup>  
theflooringgroup